

# HellermannTyton T50SOSEC13E Edge Fastening 1 to 3mm - Pack of 5000

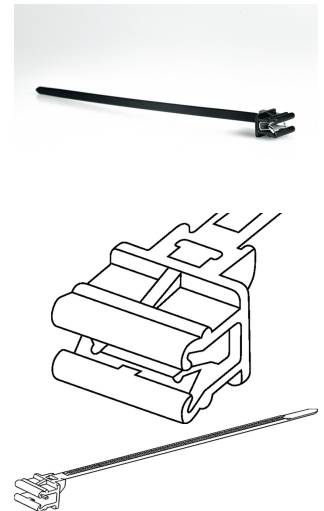



Product Images

Product Code: R02-1963

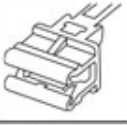

TYPE	Drawing	Panel Thickness (mm)	Width (mm)	Length (mm)	Strap #	Material	Colour	Temp	Article No.
TYTONSOSEC R02-1962		1.0 - 3.0	4.5	100.0	31.0	PA66	Black R02	24.1/30	130-02114
TYTONSOSEC R02-1963		1.0 - 3.0	4.5	100.0	31.0	PA66	Black R02	24.1/30	130-02115
TYTONSOSEC R02-1964		1.0 - 3.0	4.5	100.0	31.0	PA66	Black R02	24.1/30	130-02116

### EdgeClip-Series, 1.0 - 3.0 mm

TYPE	Drawing	Panel Thickness	Width (W)	Length (L)	Bundle Ø max.		Material	Colour	Tools	Article-No.
T50SOSEC12E R02-1962		1.0 - 3.0	4.6	160.0	35.0	180	PA66W	Black (BK)	2-8;10	126-00374
T50SOSEC13E R02-1963		1.0 - 3.0	4.6	160.0	35.0	180	PA66W	Black (BK)	2-8;10	126-00373
T50SOSEC34E R02-1964		1.0 - 3.0	4.6	155.0	35.0	180	PA66W	Black (BK)	2-8;10	126-00375

All dimensions in mm. Subject to technical changes.

### EdgeClip-Series, 1.0 - 3.0 mm, top fixing

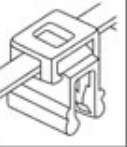
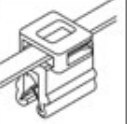
TYPE	Drawing	Width (W)	Length (L)	Bundle Ø max.		Material	Colour	Tools	Article-No.
T50ROSEC4A R02-1969		4.6	200.0	45.0	225	PA66W	Black (BK)	2-8;10	156-00570
T50ROSEC4B R02-1966		4.6	200.0	45.0	225	PA66W	Black (BK)	2-8;10	156-01154

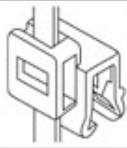
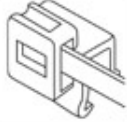

All dimensions in mm. Subject to technical changes.

### EdgeClip-Series, 1.0 - 3.0 mm, side fixing

TYPE	Drawing	Width (W)	Length (L)	Bundle Ø max.		Material	Colour	Tools	Article-No.
T50ROSEC5A R02-1970		4.6	200.0	45.0	225	PA66W	Black (BK)	2-8;10	156-00661
T50ROSEC5B R02-1971		4.6	200.0	45.0	225	PA66W	Black (BK)	2-8;10	156-00698

All dimensions in mm. Subject to technical changes.

### EdgeClip-Series, 3.0 - 6.0 mm, side fixing

TYPE	Drawing	Width (W)	Length (L)	Bundle Ø max.		Material	Colour	Tools	Article-No.
T50ROSEC23 R02-1965		4.6	200.0	45.0	225	PA66W	Black (BK)	2-8;10	156-00843

All dimensions in mm. Subject to technical changes.

## Short Description

---

Cable ties with EdgeClips are ideal where holes are not acceptable and there is no other way to route cables along an edge. This is often the case when connected module leads are too short to be fixed to substructures.

Another common scenario is keeping solar cables out of substructure metallic ducts or away from roof surfaces that can be flooded with water, causing inverter faults over time.

The EdgeClip can be easily pushed onto the edge by hand without any tools. The integrated metal clamp delivers reliably high extraction force.

Both cable tie and EdgeClip housing are manufactured of UV-stabilised PA6.6 specifically suitable for PV applications in temperate climate zones.

HellermannTyton's Cable Tie with Edge Clip is designed to route bundles by securing them to the edge of a plastic or metal sheet without the need for a mounting hole.

The clip is easy to secure, and the extraction force is high due to the integrated metal clamp that holds the edge clip in place. This fastener is molded as a one-piece clip and tie combination.

### Features

Easy assembly, just clip on by hand

For edges of 1 - 3 mm

Integrated metal clamp holds clip firmly in place

Clamp consists of double tempered steel spring

Ideal for applications where holes or adhesives are not suitable

ELV compliant Dir. Art. 4 (2) YES

Flammability UL 94 V2

Halogen free Yes

Hazardous good No

Operating Temperature - °C -40 °C to +85 °C, (+105 °C, 500 h)

Cable Tie 160 x 4.6mm

Max Bundle diameter 35mm

Supplied in a pack of 5000

HellermannTyton Art.-No. 126-00373 | T50SOSEC13E-PA66W-BK

## Description

---

Cable ties with EdgeClips are ideal where holes are not acceptable and there is no other way to route

cables along an edge. This is often the case when connected module leads are too short to be fixed to substructures.

Another common scenario is keeping solar cables out of substructure metallic ducts or away from roof surfaces that can be flooded with water, causing inverter faults over time.

The EdgeClip can be easily pushed onto the edge by hand without any tools. The integrated metal clamp delivers reliably high extraction force.

Both cable tie and EdgeClip housing are manufactured of UV-stabilised PA6.6 specifically suitable for PV applications in temperate climate zones.

HellermannTyton's Cable Tie with Edge Clip is designed to route bundles by securing them to the edge of a plastic or metal sheet without the need for a mounting hole.

The clip is easy to secure, and the extraction force is high due to the integrated metal clamp that holds the edge clip in place. This fastener is molded as a one-piece clip and tie combination.

### Features

Easy assembly, just clip on by hand

For edges of 1 - 3 mm

Integrated metal clamp holds clip firmly in place

Clamp consists of double tempered steel spring

Ideal for applications where holes or adhesives are not suitable

ELV compliant Dir. Art. 4 (2) YES

Flammability UL 94 V2

Halogen free Yes

Hazardous good No

Operating Temperature - °C -40 °C to +85 °C, (+105 °C, 500 h)

Cable Tie 160 x 4.6mm

Max Bundle diameter 35mm

Supplied in a pack of 5000

HellermannTyton Art.-No. 126-00373 | T50SOSEC13E-PA66W-BK