



Mills Limited
 Unit 2,
 Zodiac Business Park,
 High Road,
 Cowley
 Uxbridge
 UB8 2GU

Contact us on:
 Tel: 020 8833 2626
 Fax: 020 8833 2600
 Email: sales@millsltd.com

Company No. 00282704
 VAT No. 227082574

HellermannTyton T50ROSEC4A

Edge Fastening 1 to 3mm - Pack of 500

Product Images

Product Code: R02-1969

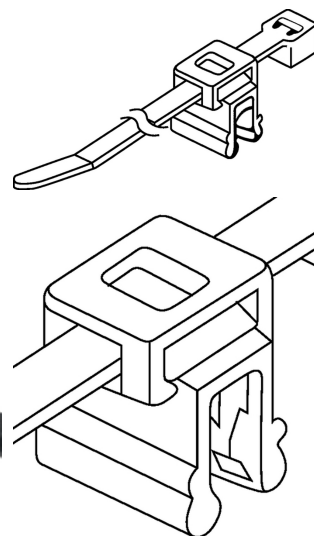
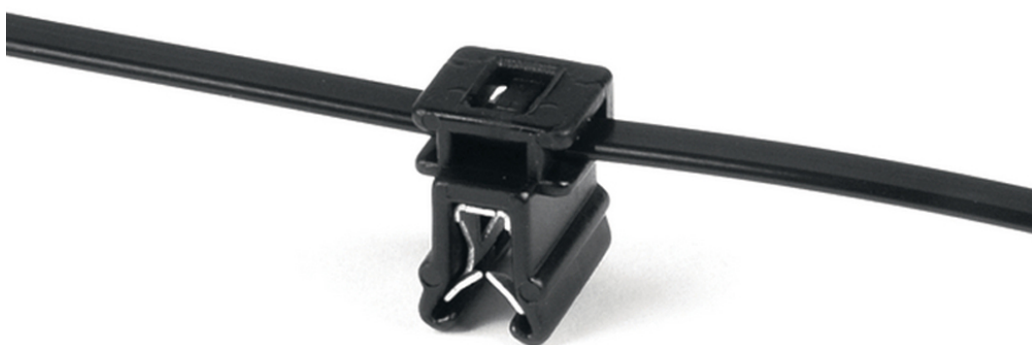



Edge/Fix/Sec4A 1.0 - 3.0 mm, top view

TYPE	Drawing	Width (mm)	Length (mm)	Number of pins	Material	Colour	Tests	Article No.
T50ROSEC4A R02-1969		4.4	200.0	45.0	275	PA6666	Black (R02)	2-4-10 154-000010
T50ROSEC4A R02-1969		4.4	200.0	45.0	275	PA6666	Black (R02)	2-4-10 154-01154

Edge/Fix/Sec4A 1.0 - 3.0 mm, side view

TYPE	Drawing	Width (mm)	Length (mm)	Number of pins	Material	Colour	Tests	Article No.
T50ROSEC4A R02-1970		4.4	200.0	45.0	275	SH6666	Black (R02)	2-4-10 154-000011
T50ROSEC4A R02-1971		4.4	200.0	45.0	275	SH6666	Black (R02)	2-4-10 154-000012

EdgeClip-Series, 1.0 - 3.0 mm

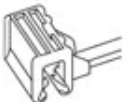
TYPE	Drawing	Panel Thickness	Width (W)	Length (L)	Bundle Ø max.		Material	Colour	Tools	Article-No.
T50SOSEC12E R02-1962		1.0 - 3.0	4.6	160.0	35.0	180	PA66W	Black (BK)	2-8;10	126-00374
T50SOSEC13E R02-1963		1.0 - 3.0	4.6	160.0	35.0	180	PA66W	Black (BK)	2-8;10	126-00373
T50SOSEC34E R02-1964		1.0 - 3.0	4.6	155.0	35.0	180	PA66W	Black (BK)	2-8;10	126-00375

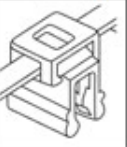
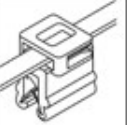

All dimensions in mm. Subject to technical changes.

EdgeClip-Series, 1.0 - 3.0 mm, top fixing

TYPE	Drawing	Width (W)	Length (L)	Bundle Ø max.		Material	Colour	Tools	Article-No.
T50ROSEC4A R02-1969		4.6	200.0	45.0	225	PA66W	Black (BK)	2-8;10	156-00570
T50ROSEC4B R02-1966		4.6	200.0	45.0	225	PA66W	Black (BK)	2-8;10	156-01154

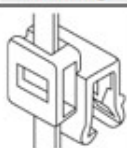

All dimensions in mm. Subject to technical changes.

EdgeClip-Series, 1.0 - 3.0 mm, side fixing

TYPE	Drawing	Width (W)	Length (L)	Bundle Ø max.		Material	Colour	Tools	Article-No.
T50ROSEC5A R02-1970		4.6	200.0	45.0	225	PA66W	Black (BK)	2-8;10	156-00661
T50ROSEC5B R02-1971		4.6	200.0	45.0	225	PA66W	Black (BK)	2-8;10	156-00698

All dimensions in mm. Subject to technical changes.

EdgeClip-Series, 3.0 - 6.0 mm, side fixing

TYPE	Drawing	Width (W)	Length (L)	Bundle Ø max.		Material	Colour	Tools	Article-No.
T50ROSEC23 R02-1965		4.6	200.0	45.0	225	PA66W	Black (BK)	2-8;10	156-00843

All dimensions in mm. Subject to technical changes.

Short Description

These cable tie and EdgeClip assemblies are ideal for use where holes are not acceptable or where due to temperature problems adhesives will fail.

These assemblies are widely used for fixing and bundling cables, pipes and hoses within the automotive industry, harness making, panel building and electrical industry.

These two piece assemblies simply push onto an edge with thicknesses from 1.0 to 3.0mm. The high 'pull off' forces are due to the integrated metal clamp. Different Edge Clip variations are available. One version allows for cables to run parallel to the edge, whilst another allows for installation at 90 degrees to the edge. The clip is simply pushed on by hand and held firmly in place by the integrated metal clamp. No fixing hole is necessary. Combined with the outside serrated (OS) ties, specially designed to protect cables from chafing and wear, the Edge Clip family provides an excellent fastening solution.

Foot Part Polyamide 6.6, UV-resistant (PA66W)

Material Polyamide 6.6, UV-resistant (PA66W)

Pack Size 500pcs.

Variant Outside Serrated

ELV compliant Dir. Art. 4 (2) YES

Flammability UL 94 V2

Operating Temperature - °C -40 °C to +85 °C, (+105 °C, 500 h)

Top fixing for edges 1.0 to 3.0mm thickness.

HellermannTyton Art.-No. 156-00570 | T50ROSEC4A-PA66W-BK

Description

These cable tie and EdgeClip assemblies are ideal for use where holes are not acceptable or where due to temperature problems adhesives will fail.

These assemblies are widely used for fixing and bundling cables, pipes and hoses within the automotive industry, harness making, panel building and electrical industry.

These two piece assemblies simply push onto an edge with thicknesses from 1.0 to 3.0mm. The high 'pull off' forces are due to the integrated metal clamp. Different Edge Clip variations are available. One version allows for cables to run parallel to the edge, whilst another allows for installation at 90 degrees to the edge. The clip is simply pushed on by hand and held firmly in place by the integrated metal clamp. No fixing hole is necessary. Combined with the outside serrated (OS) ties, specially designed to protect cables from chafing and wear, the Edge Clip family provides an excellent fastening solution.

Foot Part Polyamide 6.6, UV-resistant (PA66W)

Material Polyamide 6.6, UV-resistant (PA66W)

Pack Size 500pcs.

Variant Outside Serrated

ELV compliant Dir. Art. 4 (2) YES

Flammability UL 94 V2

Operating Temperature - °C -40 °C to +85 °C, (+105 °C, 500 h)

Top fixing for edges 1.0 to 3.0mm thickness.

HellermannTyton Art.-No. 156-00570 | T50ROSEC4A-PA66W-BK